

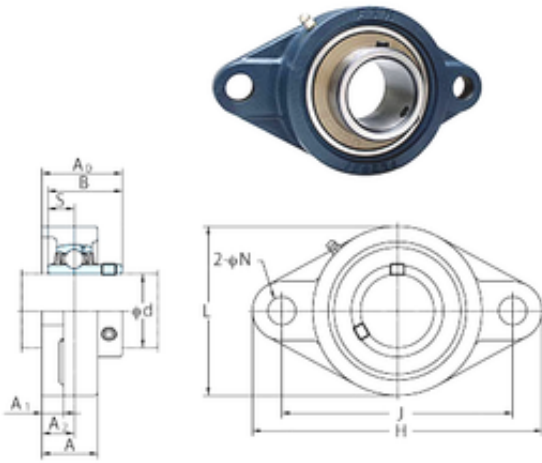

# BEARING USA CORP.

## FYH UCFL214 Bearing units

Bearing No. UCFL214



UCFL214 Bearing 2D drawings and 3D CAD models

Bore Diameter	70 mm
d	70 mm
A0	75,4 mm
A	54 mm
A1	20 mm
B	74,6 mm
H	265 mm
J	216 mm
L	160 mm
N	23 mm
S	30,2 mm
Bolt (G)	14,5
Bolt (G)	M20
A2	31 mm
Weight	5,7 Kg
Basic static load rating (C0)	62,2 kN
Category	Mounted Units & Inserts
Inventory	0.0
Manufacturer Name	FYH BEARING UNITS
Minimum Buy Quantity	N/A
Weight / Kilogram	0
Product Group	M06110